

Product Reference Manual
SKU: ABX00051

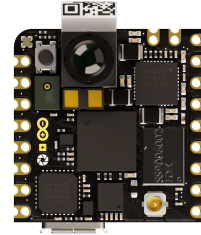

Description

The **Arduino® Nicla Vision** packs machine vision capabilities on the edge into a tiny fingerprint. Record, analyse and upload to the Cloud all with the help of one **Arduino® Nicla Vision**. Leverage the onboard camera, STM32 microcontroller, Wi-Fi®/Bluetooth® module and 6-axis IMU to create your own wireless sensor network for machine vision applications.

Target Areas

Wireless sensor networks, data fusion, artificial intelligence, machine vision

Features

- **STM32H747AIH6** Microcontroller Dual-core
 - 32-bit Arm® Cortex®-M7 core with double-precision FPU and L1 cache up to 480 MHz
 - 32-bit Arm® 32-bit Cortex®-M4 core with FPU up to 240 MHz
 - Full set of DSP instructions
 - Memory Protection Unit (MPU)
- **Murata® 1DX** Wi-Fi®/Bluetooth® Module
 - Wi-Fi® 802.11b/g/n 65 Mbps
 - Bluetooth® 4.2 BR/EDR/LE
- **MAX17262REWL+T** Fuel Gauge
 - Implements ModelGauge m5 EZ for battery monitoring
 - Low 5.2 µA Operating Current
 - No Calibration Required
- **NXP® SE050C2** Crypto
 - Common Criteria EAL 6+ certified up to OS level
 - RSA & ECC functionalities, high key length and future-proof curves, such as brainpool, Edwards, and Montgomery
 - AES & 3DES encryption and decryption
 - HMAC, CMAC, SHA-1, SHA-224/256/384/512 operations
 - HKDF, MIFARE® KDF, PRF (TLS-PSK)
 - Support of main TPM functionalities
 - Secured flash user memory up to 50 kB
 - SCP03 (bus encryption and encrypted credential injection on applet and platform level)
- **VL53L1CBV0FY/1** Time-of-Flight Sensor
 - Fully integrated miniature module
 - 940 nm invisible laser (VCSEL) emitter
 - Receiving array with integrated lens
 - 400 cm detection with a full field of view (FoV)
- **MP34DT06JTR** Microphone
 - AOP = 122.5 dB SPL
 - 64 dB signal-to-noise ratio
 - Omnidirectional sensitivity
 - -26 dBFS ± 1 dB sensitivity

- **GC2145** Camera
 - 2 Megapixel CMOS Camera
 - on-chip 10-bit ADC
 - 1.75 μm pixel size
 - Focal length: 2.2 mm
 - F-value: $2.2 \pm 5\%$
 - View angle: 80°
 - Distortion: $< 1.0\%$
- **LSM6DSOX** 6-axis IMU
 - Always-on 3D accelerometer and 3D gyroscope
 - Smart FIFO up to 4 kByte
 - $\pm 2/\pm 4/\pm 8/\pm 16$ g full scale
 - $\pm 125/\pm 250/\pm 500/\pm 1000/\pm 2000$ dps full scale
- **USB3320C-EZK-TR** USB Transceiver
 - Integrated ESD Protection circuit (up to $\pm 15\text{kV}$ IEC Air Discharge)
- **AT25QL128A-UUE-T** 16 MB Flash
- **MC34PF1550A0EP** Power Management IC

Contents

1 Introduction	6
1.1 Application Examples	6
1.2 Accessories (Not Included)	6
1.3 Related Products	7
1.4 Assembly Overview	7
2 Ratings	8
2.1 Recommended Operating Conditions	8
2.2 Power Consumption	8
3 Functional Overview	9
3.1 Block Diagram	9
3.2 Board Topology	10
3.3 Processor	12
3.4 6-Axis IMU	12
3.5 Wi-Fi®/Bluetooth® Connectivity	12
3.6 Crypto Capabilities	12
3.7 Time of Flight Sensor	12
3.8 Digital Microphones	13
3.9 Power Tree	13
4 Board Operation	14
4.1 Getting Started - IDE	14
4.2 Getting Started - Arduino Web Editor	14
4.3 Getting Started - Arduino Cloud	14
4.4 Getting Started - WebBLE	15
4.5 Getting Started - ESLOV	15
4.6 Sample Sketches	15
4.7 Online Resources	15
4.8 Board Recovery	15
5 Connector Pinouts	15
5.1 J1 Pin Connector	15
5.2 J2 Pin Header	16
5.3 J2 Fins	16
5.4 J3 Battery Pads	16
5.5 J4 Battery Connector	17

5.6 J5 ESLOV	17
6 Mechanical Information	18
7 Certifications	19
7.1 Product Labeling	19
7.2 Declaration of Conformity CE DoC (EU)	19
7.3 Declaration of Conformity to EU RoHS & REACH 211 01/19/2021	20
7.4 Conflict Minerals Declaration	20
8 FCC Caution	21
9 Company Information	22
10 Reference Documentation	22
11 Revision History	23

1 Introduction

1.1 Application Examples

The **Arduino® Nicla Vision** houses the computational power, camera and IMU you need to quickly develop machine vision solutions at the edge together with two wireless technologies. The board can act as a field-ready standalone board or can be augmented with external peripherals through the I/O available on the chip. Ultra-low power consumption and integrated battery management allow for deployment in various capabilities. WebBLE allows for easy OTA updates to the firmware as well as remote monitoring.

- **Warehouse & Automated Inventory Management:** The **Arduino Nicla Vision** is capable of detecting packages as they come near its vicinity and wake up. These provide the benefits of an always-on camera but with less power consumption. It can take pictures, predict volume/weight and also analyze for possible defects. Additionally, QR codes on the package can be tracked for automated pursuit of the package and relay of information to the Cloud.
- **Real-time process management:** The **Arduino Nicla Vision** is equipped for Automated Optical Inspection (AOI) even in hard-to-reach and hazardous areas thanks to the small footprint and wireless connectivity options. The fast Time-of-Flight sensor ensures that the image acquisition is performed in a repeatable manner, with minimal modifications to the process. Additionally, the IMU can provide vibration analysis for predictive maintenance.
- **Wireless Sensor Network Reference Design:** The Nicla form factor has been specifically developed at Arduino® as a standard for wireless sensor networks which can be adapted by partners to develop custom-designed industrial solutions. Researchers and educators can use this platform to work on an industrially recognized standard for wireless sensor research and development that can shorten the time from concept to market.

1.2 Accessories (Not Included)

- Single-cell Li-ion/Li-Po battery

1.3 Related Products

- Arduino® Portenta H7 (SKU: ABX00042)

1.4 Assembly Overview

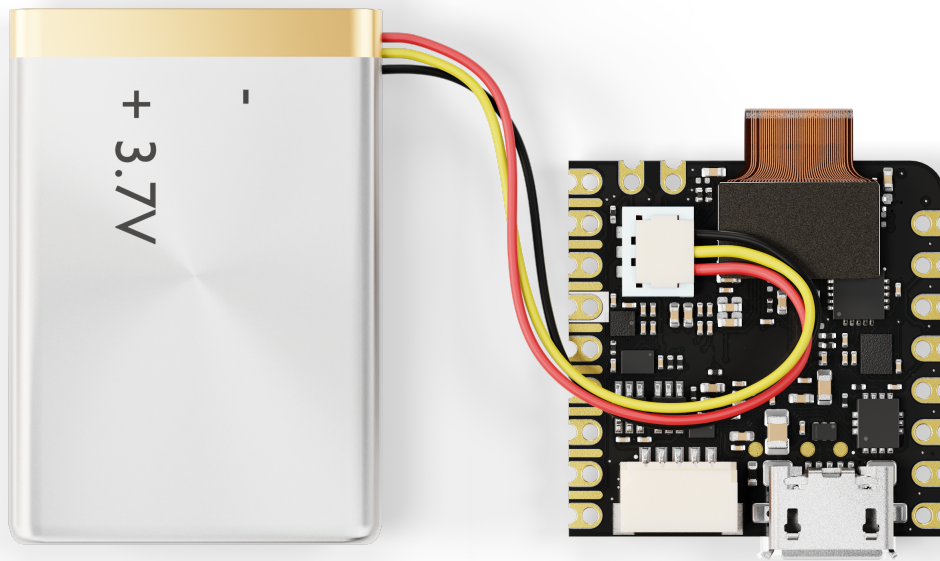

Example of a typical solution for remote machine vision including an Arduino® Nicla Vision and battery. Notice the orientation of the battery's cable in the board's connector.

Note: The NTC pin on the battery connector is optional. This is a feature that allows a safer use and thermal shutoff of the PMIC.

2 Ratings

2.1 Recommended Operating Conditions

Symbol	Description	Min	Typ	Max	Unit
V_{IN}	Input voltage from VIN pad	3.5	5.0	5.5	V
V_{USB}	Input voltage from USB connector	4.8	5.0	5.5	V
V_{BATT}	Input voltage from battery	3.5	3.7	4.7	V
V_{DDIO_EXT}	Level Translator Voltage	1.8	3.3	3.3	V
V_{IH}	Input high-level voltage	$0.7 \cdot V_{DDIO_EXT}$		V_{DDIO_EXT}	V
V_{IL}	Input low-level voltage	0		$0.3 \cdot V_{DDIO_EXT}$	V
T_{OP}	Operating Temperature	-40	25	85	°C

Note 1: V_{DDIO_EXT} is software programmable. While the ADC inputs can accept up to 3.3V, the AREF value is at the STM32 operating voltage.

Note 2: If the internal V_{DDIO_EXT} is disabled, it is possible to supply it externally.

2.2 Power Consumption

Description	Min	Typ	Max	Unit
Average current consumption in deep sleep mode		374		uA
Average current consumption during image capture		105		mA

Note: The measurements have been performed with a battery power supply (200mAh Li-ion battery) and OpenMV IDE firmware version 4.3.4.

3 Functional Overview

3.1 Block Diagram

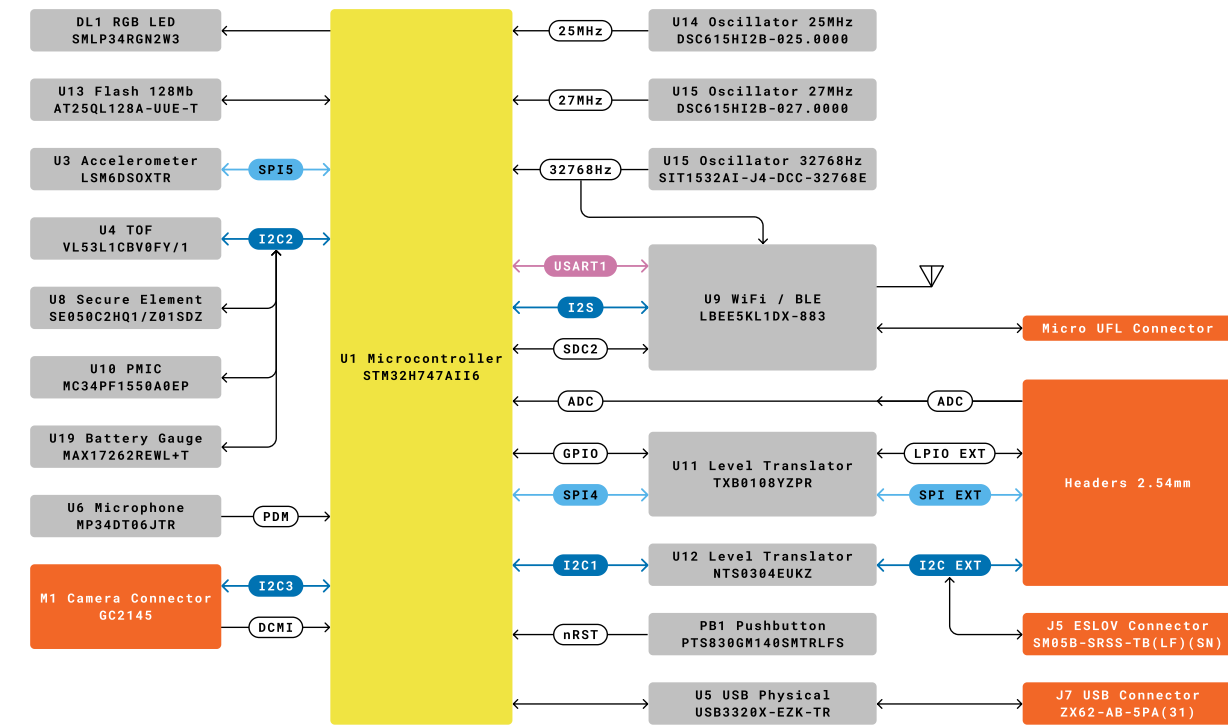

Legend:	■ Connector	■ I2C/I2S	 Other SERIAL
	■ Main Part	■ SPI	
	■ Internal Part	■ UART/USART	



Arduino
 Nicla Vision
 SKU code: ABX00051
 Block Diagram
 Last update: 11 Aug, 2022

Nicla Vision Block Diagram

3.2 Board Topology

Top View

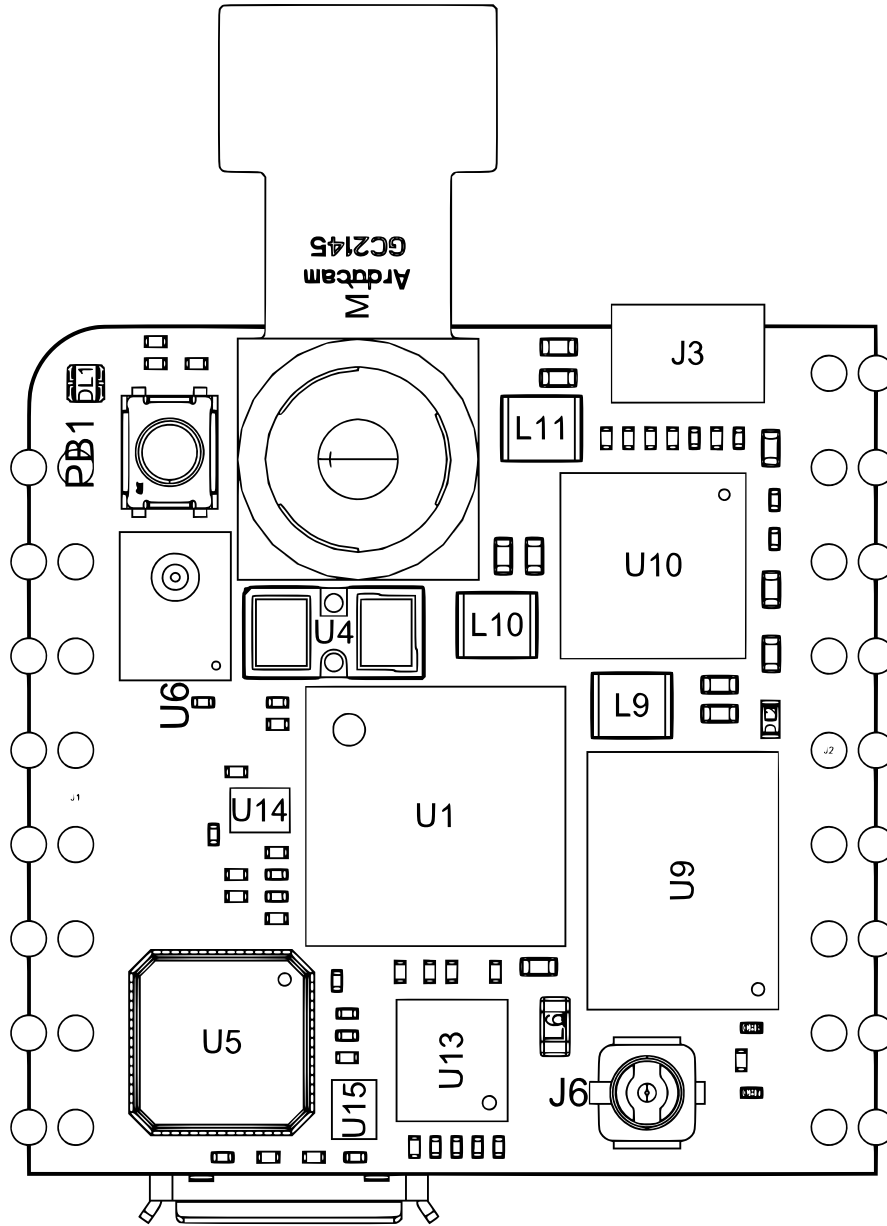

Nicla Vision Top View

Ref.	Description	Ref.	Description
U1	STM32H747AI16 Dual Arm® Cortex® M7/M4 IC	U4	VL53L1CBV0FY/1 Time-of-flight sensor IC
U5	USB3320C-EZK-TR USB 2.0 Transceiver	U6	MP34DT06JTR Omnidirectional Mic
U14	DSC6151HI2B 25 MHz MEMS Oscillator	U15	DSC6151HI2B 27 MHz MEMS Oscillator
U8	IS31FL3194-CLS2-TR 3-channel LED IC	U9	BQ25120AYFPR Battery Charger IC
U10	SN74LVC1T45 1-channel voltage level translator IC	U11	TXB0108YZPR Bidirectional IC
U12	NTS0304EUKZ 4-bit translating transceiver	J1	ADC, SPI and LPIO Pin headers
J2	I2C, JTAG, Power and LPIO pin headers	J3	Battery headers

Ref.	Description	Ref.	Description
DL1	SMLP34RGB2W3 RGB SMD LED	DL2	KPHHS-1005SURCK Red LED
PB1	Reset button	J6	U.FL-R-SMT-1(60) Male micro UFL connector

Back View

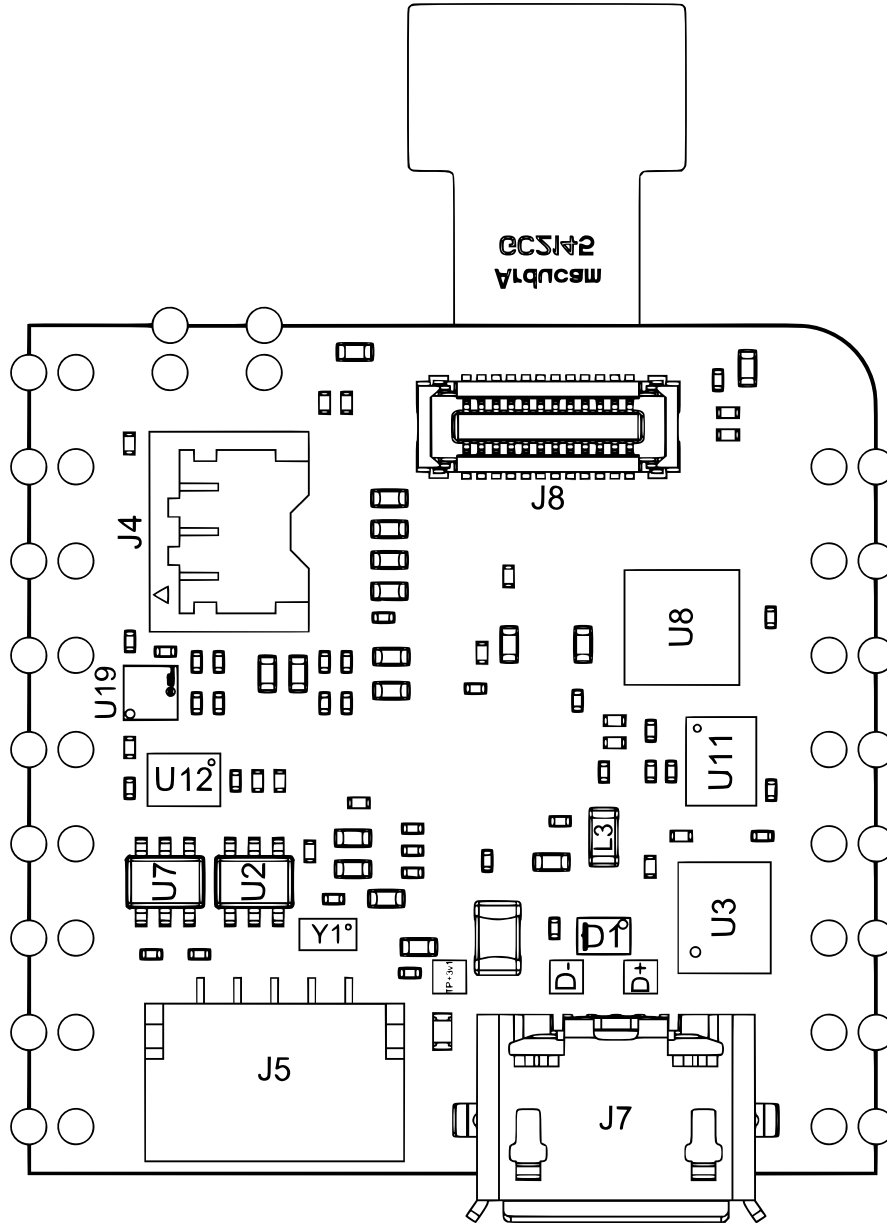

Nicla Vision Back View

Ref.	Description	Ref.	Description
U2,U7	LM66100DCKR Ideal Diode	U3	LSM6DSOXTR 6-axis IMU with ML Core
U8	SE050C2HQ1/Z01SDZ Crypto IC	U9	LBEE5KL1DX-883 Wi-Fi®/Bluetooth® Module
U10	MC34PF1550A0EP PMIC	U11	TXB0108YZPR Bidirectional Voltage Shifter
U12	NTS0304EUKZ Bidirectional Voltage Shifter	U13	AT25QL128A-UUE-T 16 MB FLASH Memory IC
U19	MAX17262REWL+T Fuel Gauge IC	J4	BM03B-ACHSS-GAN-TF(LF)(SN) 3-pin battery connector

Ref.	Description	Ref.	Description
J5	SM05B-SRSS-TB(LF)(SN) 5-pin ESLOV connector	J7	microUSB connector

3.3 Processor

The Nicla Vision's main processor is the dual-core STM32H747 (U1) including a Cortex® M7 running at 480 MHz and a Cortex® M4 running at 240 MHz. The two cores communicate via a Remote Procedure Call mechanism that allows calling functions on the other processor seamlessly.

3.4 6-Axis IMU

It is possible to obtain 3D gyroscope and 3D accelerometer data from the LSM6DSOX 6-axis IMU (U3). In addition to providing such data, it is also possible to do machine learning on the IMU for gesture detection, offloading computation load from the main processor.

3.5 Wi-Fi®/Bluetooth® Connectivity

The Murata® LBEE5KL1DX-883 wireless module (U9) simultaneously provides Wi-Fi® and Bluetooth® connectivity in an ultra-small package based on the Cypress CYW4343W. The IEEE802.11 b/g/n Wi-Fi® interface can be operated as an access point (AP), station (STA) or dual-mode simultaneous AP/STA. It supports a maximum transfer rate of 65 Mbps. Bluetooth® interface supports Bluetooth® Classic and BLE. An integrated antenna circuitry switch allows a single external antenna (J6) to be shared between Wi-Fi® and Bluetooth®.

3.6 Crypto Capabilities

The Arduino® Nicla Vision enables IC-level edge-to-cloud security capability through the NXP SE050C2 Crypto chip (U8). This provides Common Criteria EAL 6+ security certification up to OS level, as well as RSA/ECC cryptographic algorithm support and credential storage.

3.7 Time of Flight Sensor

The VL53L1CBV0FY Time-of-Flight sensor (U4) adds accurate and low power ranging capabilities to the Arduino® Nicla Vision. The invisible near-infrared VCSEL laser (including the analog driver) is encapsulated together with receiving optics in an all-in-one small module located below the camera.

3.8 Digital Microphones

The MP34DT05 digital MEMS microphone is omnidirectional and operates via a capacitive sensing element with a high (64 dB) signal-to-noise ratio. The sensing element, capable of detecting acoustic waves, is manufactured using a specialized silicon micromachining process dedicated to producing audio sensors (U6).

3.9 Power Tree

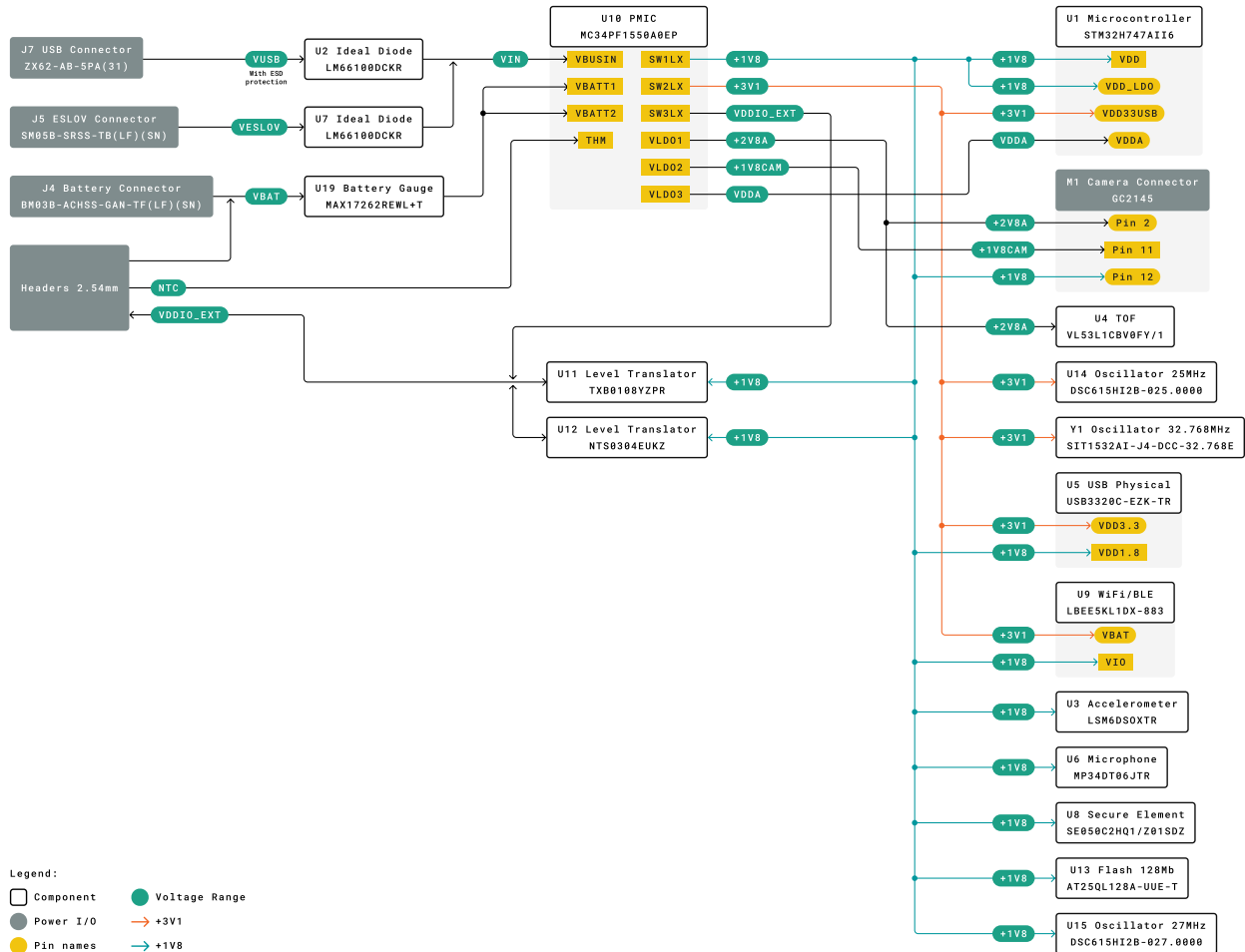

Nicla Vision Power Tree

Input voltage can be provided to the Nicla Vision through the USB connector (J7), the ESLOV connector (J5), the battery connector (J4) or alternatively the headers. The USB connector is prioritized over the ESLOV connector, both of which are prioritized over the battery connector and header. Reverse polarity protection for the USB connector (J7) and the ESLOV connector (J5) are provided by ideal diodes U2 and U7 respectively. Input voltage from the battery does NOT have reverse polarity protection and the user is responsible for respecting the polarity.

An NTC (negative thermal coefficient) sensor provides overtemperature shutoff to the battery. The battery fuel gauge provides an indication of the remaining battery capacity.

There are three main power lines provided:

- **+3V1** provides power to the microprocessor (U1), 25 MHz oscillator (U14), 32.768 MHz oscillator (Y1), USB transceiver (U5) and Wi-Fi®/Bluetooth® module.
- **+2V8A** provides power to the camera (M1) and time-of-flight sensor (U4)
- **+1V8** provides power to the microprocessor (U1), camera (M1), USB transceiver (U5), Wi-Fi®/Bluetooth® module (U9), accelerometer (U3), microphone (U6), crypto (U8), FLASH (U13), 27 MHz oscillator (U15) as well as the two level translators (U11, U12).
- Additionally, a dedicated analog supply rail (VDDA) is provided for the microcontroller (U1). The camera module (M1) also has a dedicated power rail (+1V8CAM).

4 Board Operation

4.1 Getting Started - IDE

If you want to program your Arduino® Nicla Vision while offline you need to install the Arduino® Desktop IDE **[1]** To connect the Arduino® Vision to your computer, you'll need a micro USB cable. This also provides power to the board, as indicated by the LED.

4.2 Getting Started - Arduino Web Editor

All Arduino® boards, including this one, work out-of-the-box on the Arduino® Web Editor **[2]**, by just installing a simple plugin.

The Arduino® Web Editor is hosted online, therefore it will always be up-to-date with the latest features and support for all boards. Follow **[3]** to start coding on the browser and upload your sketches onto your board.

4.3 Getting Started - Arduino Cloud

All Arduino® IoT enabled products are supported on Arduino® Cloud which allows you to log, graph and analyze sensor data, trigger events, and automate your home or business.

4.4 Getting Started - WebBLE

The Arduino Nicla Vision provides the capability for OTA updates to the STM32 microcontroller using WebBLE.

4.5 Getting Started - ESLOV

This board can act as a secondary to an ESLOV controller and have the firmware updated through this method.

4.6 Sample Sketches

Sample sketches for the Arduino® Nicla Vision can be found either in the “Examples” menu in the Arduino® IDE or on the Arduino® documentation website [4]

4.7 Online Resources

Now that you have gone through the basics of what you can do with the board you can explore the endless possibilities it provides by checking exciting projects on ProjectHub [5], the Arduino® Library Reference [6] and the online store [7] where you will be able to complement your board with sensors, actuators and more.

4.8 Board Recovery

All Arduino® boards have a built-in bootloader which allows flashing the board via USB. In case a sketch locks up the processor and the board is not reachable anymore via USB it is possible to enter bootloader mode by double-tapping the reset button right after a power-up.

5 Connector Pinouts

Note 1: All the pins on J1 and J2 (excluding fins) are referenced to the V_{DDIO_EXT} voltage which can be generated internally or supplied externally. **Note 2:** I2C1 is connected to the level translator U12 which has internal 10k pullups. R9 and R10 pull-up resistors are not mounted on the board.

5.1 J1 Pin Connector

Pin	Function	Type	Description
1	D0/LPIO0	Digital	Digital IO 0 / Low Power IO Pin 0
2	A2/D18	Analog	Analog Input 2 / Digital IO 18
3	SS	Digital	SPI Slave Select
4	COPI	Digital	SPI Controller Out / Peripheral In
5	CIPO	Digital	SPI Controller In / Peripheral Out
6	SCK	Digital	SPI Clock
7	A1/D17	Analog	Analog Input 1 / Digital IO 17
8	A0/D16	Analog	Analog Input 0 / Digital IO 16

5.2 J2 Pin Header

Pin	Function	Type	Description
1	SDA	Digital	I2C Data Line
2	SCL	Digital	I2C Clock
3	D1/LPIO1/UART_TX	Digital	Digital IO 1 / Low Power IO Pin 1 / Serial Transmission Pin
4	D2/LPIO2/UART_RX	Digital	Digital IO 2 / Low Power IO Pin 2 / Serial Reception Pin
5	D3/LPIO3	Digital	Digital IO 3 / Low Power IO Pin 3
6	GND	Power	Ground
7	VDDIO_EXT	Digital	Logic Level Reference
8	N/C	N/A	N/A
9	VIN	Digital	Input Voltage

Note: For further information on how Low Power I/Os work, check Nicla Family Form Factor documentation.

5.3 J2 Fins

Pin	Function	Type	Description
P1	SDA_PMIC	Digital	PMIC I2C Data Line
P2	SCL_PMIC	Digital	PMIC I2C Clock Line
P3	TDO/SWD	Digital	Data SWD JTAG Interface
P4	TCK/SCK	Digital	Clock of SWD JTAG
P5	TMS/NRST	Digital	Reset Pin
P6	SWO	Digital	Output of SWD JTAG Interface
P7	+1V8	Power	+1.8V Voltage Rail
P8	VOTP_PMIC	Digital	Reserved

5.4 J3 Battery Pads

Pin	Function	Type	Description
1	VBAT	Power	Battery input
2	NTC	Analog	NTC Thermistor

5.5 J4 Battery Connector

Pin	Function	Type	Description
1	VBAT	Power	Battery input
2	NTC	Analog	NTC Thermistor
3	GND	Power	Ground

5.6 J5 ESLOV

Pin	Function	Type	Description
1	5V	Power	5V Power Rail
2	INT	Digital	Digital IO
3	SCL	Digital	I2C Clock Line
4	SDA	Digital	I2C Data Line
5	GND	Power	Ground

6 Mechanical Information

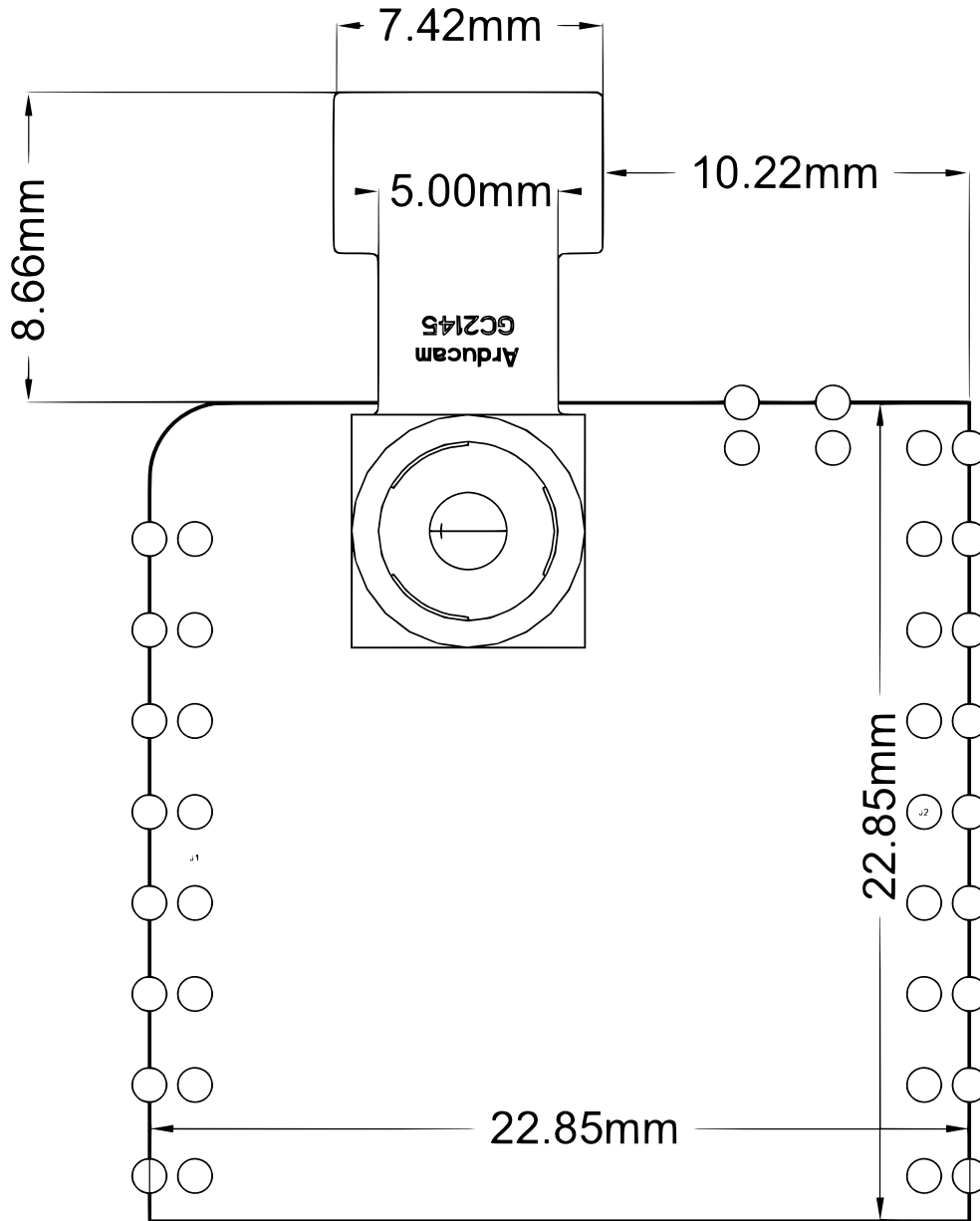



Nicla Vision Mechanical Drawing

7 Certifications

7.1 Product Labeling

The product labeling of the Arduino Nicla Vision is shown in the image below:

ARDUINO® Nicla Vision		
CE	Model (SKU): ABX00051	
FCC	FCC ID: 2AN9S-ABX00051	
IC	IC: 26792-ABX00051	RoHS✓
UK CA		Arduino S.r.l.

Nicla Vision Product Labeling

7.2 Declaration of Conformity CE DoC (EU)

We declare under our sole responsibility that the products above are in conformity with the essential requirements of the following EU Directives and therefore qualify for free movement within markets comprising the European Union (EU) and European Economic Area (EEA).

7.3 Declaration of Conformity to EU RoHS & REACH 211 01/19/2021

Arduino boards are in compliance with RoHS 2 Directive 2011/65/EU of the European Parliament and RoHS 3 Directive 2015/863/EU of the Council of 4 June 2015 on the restriction of the use of certain hazardous substances in electrical and electronic equipment.

Substance	Maximum Limit (ppm)
Lead (Pb)	1000
Cadmium (Cd)	100
Mercury (Hg)	1000
Hexavalent Chromium (Cr6+)	1000
Poly Brominated Biphenyls (PBB)	1000
Poly Brominated Diphenyl ethers (PBDE)	1000
Bis(2-Ethylhexyl} phthalate (DEHP)	1000
Benzyl butyl phthalate (BBP)	1000
Dibutyl phthalate (DBP)	1000
Diisobutyl phthalate (DIBP)	1000

Exemptions : No exemptions are claimed.

Arduino Boards are fully compliant with the related requirements of European Union Regulation (EC) 1907 /2006 concerning the Registration, Evaluation, Authorization and Restriction of Chemicals (REACH). We declare none of the SVHCs (<https://echa.europa.eu/web/guest/candidate-list-table>), the Candidate List of Substances of Very High Concern for authorization currently released by ECHA, is present in all products (and also package) in quantities totaling in a concentration equal or above 0.1%. To the best of our knowledge, we also declare that our products do not contain any of the substances listed on the "Authorization List" (Annex XIV of the REACH regulations) and Substances of Very High Concern (SVHC) in any significant amounts as specified by the Annex XVII of Candidate list published by ECHA (European Chemical Agency) 1907 /2006/EC.

7.4 Conflict Minerals Declaration

As a global supplier of electronic and electrical components, Arduino is aware of our obligations with regards to laws and regulations regarding Conflict Minerals, specifically the Dodd-Frank Wall Street Reform and Consumer Protection Act, Section 1502. Arduino does not directly source or process conflict minerals such as Tin, Tantalum, Tungsten, or Gold. Conflict minerals are contained in our products in the form of solder, or as a component in metal alloys. As part of our reasonable due diligence Arduino has contacted component suppliers within our supply chain to verify their continued compliance with the regulations. Based on the information received thus far we declare that our products contain Conflict Minerals sourced from conflict-free areas.

8 FCC Caution

Any Changes or modifications not expressly approved by the party responsible for compliance could void the user's authority to operate the equipment.

This device complies with part 15 of the FCC Rules. Operation is subject to the following two conditions:

- (1) This device may not cause harmful interference
- (2) this device must accept any interference received, including interference that may cause undesired operation.

FCC RF Radiation Exposure Statement:

1. This Transmitter must not be co-located or operating in conjunction with any other antenna or transmitter.
2. This equipment complies with RF radiation exposure limits set forth for an uncontrolled environment.
3. This equipment should be installed and operated with a minimum distance of 20cm between the radiator & your body.

Note: This equipment has been tested and found to comply with the limits for a Class B digital device, pursuant to part 15 of the FCC Rules. These limits are designed to provide reasonable protection against harmful interference in a residential installation. This equipment generates, uses and can radiate radio frequency energy and, if not installed and used in accordance with the instructions, may cause harmful interference to radio communications. However, there is no guarantee that interference will not occur in a particular installation. If this equipment does cause harmful interference to radio or television reception, which can be determined by turning the equipment off and on, the user is encouraged to try to correct the interference by one or more of the following measures:

- Reorient or relocate the receiving antenna.
- Increase the separation between the equipment and receiver.
- Connect the equipment into an outlet on a circuit different from that to which the receiver is connected.
- Consult the dealer or an experienced radio/TV technician for help.

English: User manuals for license-exempt radio apparatus shall contain the following or equivalent notice in a conspicuous location in the user manual or alternatively on the device or both. This device complies with Industry Canada license-exempt RSS standard(s). Operation is subject to the following two conditions:

- (1) this device may not cause interference
- (2) this device must accept any interference, including interference that may cause undesired operation of the device.

French: Le présent appareil est conforme aux CNR d'Industrie Canada applicables aux appareils radio exempts de license. L'exploitation est autorisée aux deux conditions suivantes:

- (1) l'appareil nedoit pas produire de brouillage
- (2) l'utilisateur de l'appareil doit accepter tout brouillage radioélectrique subi, même si le brouillage est susceptible d'en compromettre le fonctionnement.

IC SAR Warning:

English This equipment should be installed and operated with a minimum distance of 20 cm between the radiator and your body.

French: Lors de l'installation et de l'exploitation de ce dispositif, la distance entre le radiateur et le corps est d'au moins 20 cm.

Important: The operating temperature of the EUT can't exceed 85°C and shouldn't be lower than -40°C.

Hereby, Arduino S.r.l. declares that this product is in compliance with essential requirements and other relevant provisions of Directive 201453/EU. This product is allowed to be used in all EU member states.

Frequency bands	Maximum Output Power
2402 MHz ~ 2480 MHz (EDR)	-0.21 dBm
2402 MHz ~ 2480 MHz (BLE)	4.79 dBm
2412 MHz ~ 2462 MHz (2.4GHz WiFi)	16.21 dBm

9 Company Information

Company name	Arduino S.r.l.
Company Address	Via Andrea Appiani, 25 - 20900 MONZA (Italy)

10 Reference Documentation

Ref	Link
Arduino® IDE (Desktop)	https://www.arduino.cc/en/Main/Software
Arduino® IDE (Cloud)	https://create.arduino.cc/editor
Arduino® Cloud IDE Getting Started	https://create.arduino.cc/projecthub/Arduino_Genuino/getting-started-with-arduino-web-editor-4b3e4a
Arduino® Pro Website	https://www.arduino.cc/pro
Online Store	https://store.arduino.cc/

11 Revision History

Date	Revision	Changes
10/04/2024	6	Product Labeling section added - FCC information updated
28/03/2024	5	FCC Warning Updated, small fixes
05/12/2023	4	Accessories section updated
27/01/2023	3	Add power consumption information
10/01/2023	2	Updated information and fixes
03/09/2021	1	Initial Version